

Amoris Dual-band Wi-Fi Antenna

Part No. SRF2W021

flexiiANT[®]

Product Specification

1. Features

- Antenna for 2.4 – 2.5 GHz and 4.9 – 5.9 GHz applications: Wi-Fi[®] 802.11a/b/g/j/n/ac
- Maintains high performance within device: DFI (Designed For Integration)
- 1.13mm diameter RF cable with IPEX MHF connector
- Self-Adhesive mounted
- Quick integration minimizes design cycle
- High performance
- Available 3 standard cable lengths

2. Description

Amoris is intended for use with all Wi-Fi applications. A flexible antenna with cable enables direct connection to the host PCB. Simple integration with plug and play simplicity. This product specification shows the performance of the antenna to cover a typical dual band Wi-Fi reception: 2.4-2.5 GHz / 4.9-5.9GHz.

3. Applications

- Access Points
- Portable Devices
- PC-cards
- Game Consoles
- Set-Top-Box
- Network Devices
- Wearable devices
- MIMO Systems



4. Part Number

Amoris: SRF2W021-**xxx**



Note. -xxx refers to cable length option:

Part Number	Cable Length
SRF2W021-050	50mm
SRF2W021-100	100mm
SRF2W021-150	150mm

5. General Data

Product name	Amoris
Part Number	SRF2W021
Frequency	2.4-2.5GHz;4.9-6.0GHz
Polarization	Linear
Operating temperature	-40°C to +85°C
Impedance with matching	50 Ω
Weight	< 0.5 g
Antenna Assembly type	FPC Self-adhesive FPC Self-adhesive 3M 468MP
Dimensions (Antenna)	27.0 x 14.0 x 0.15 (mm)
Cable length	50 / 100 / 150 (mm)
Connection	MHF IPEX

6. RF Characteristics

	2.4 – 2.5 GHz	4.9 – 5.9 GHz	Conditions
Peak gain	2.8dBi	5.1dBi	All data measured in a loaded condition adhered to a plastic carrier free space.
Average gain	-1.30dBi	-1.20dBi	
Average efficiency	>67%	>70%	
Maximum return loss	-14dB	-10dB	
Maximum VSWR	1.7:1	1.7:1	

7. RF Performance

7.1 Return Loss

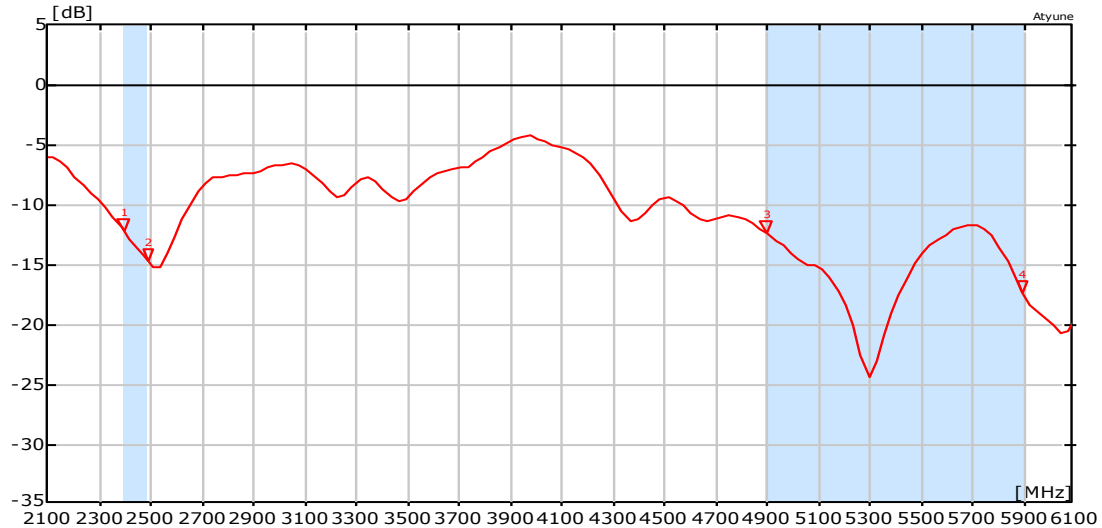

MARKERS:	MHz	dB	MHz	dB
—	1: 2401	-12.11	3: 4900	-12.28
	2: 2495	-14.59	4: 5900	-17.18

7.2 VSWR

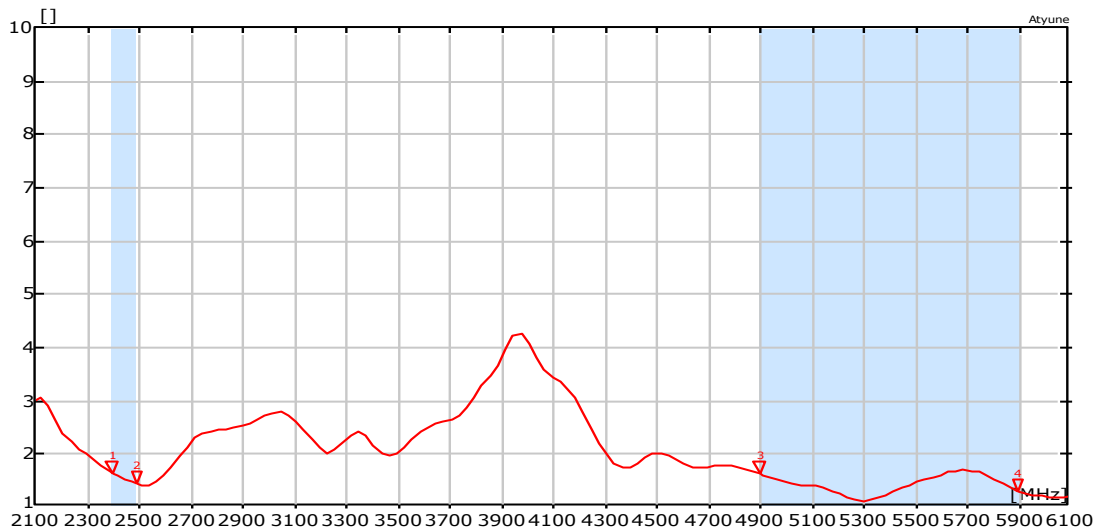

MARKERS:	MHz	V	MHz	V
—	1: 2401	1.66	3: 4900	1.64
	2: 2495	1.46	4: 5900	1.32

7.3 Antenna patterns

7.3.1 2400 MHz – 2500 MHz

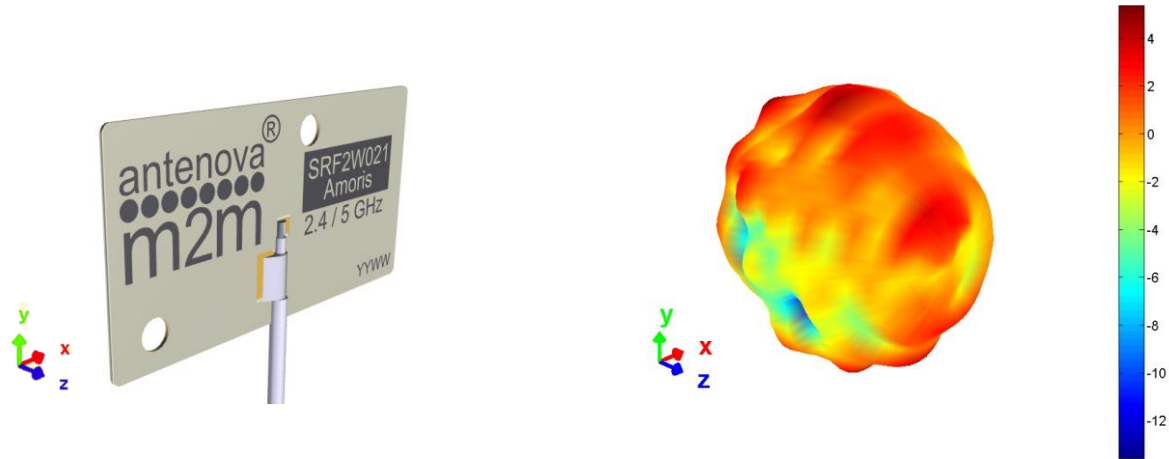

3D pattern at 2.45GHz
*Drag to rotate pattern and PCB by using Adobe Reader
(Click to Activate)*

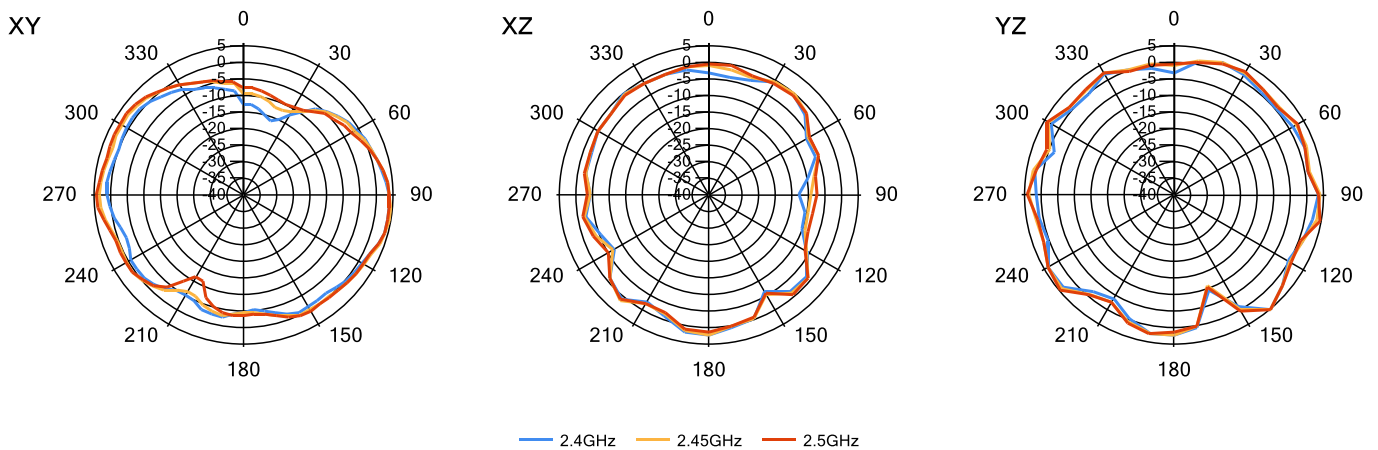

7.3.2 4900 MHz – 5900 MHz

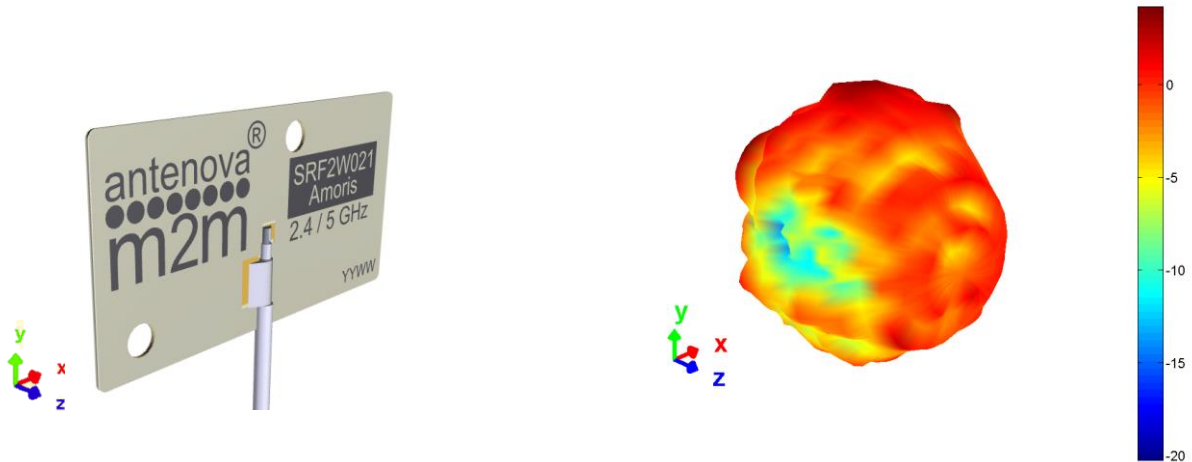

3D pattern at 5.45GHz
*Drag to rotate pattern and PCB by using Adobe Reader
(Click to Activate)*

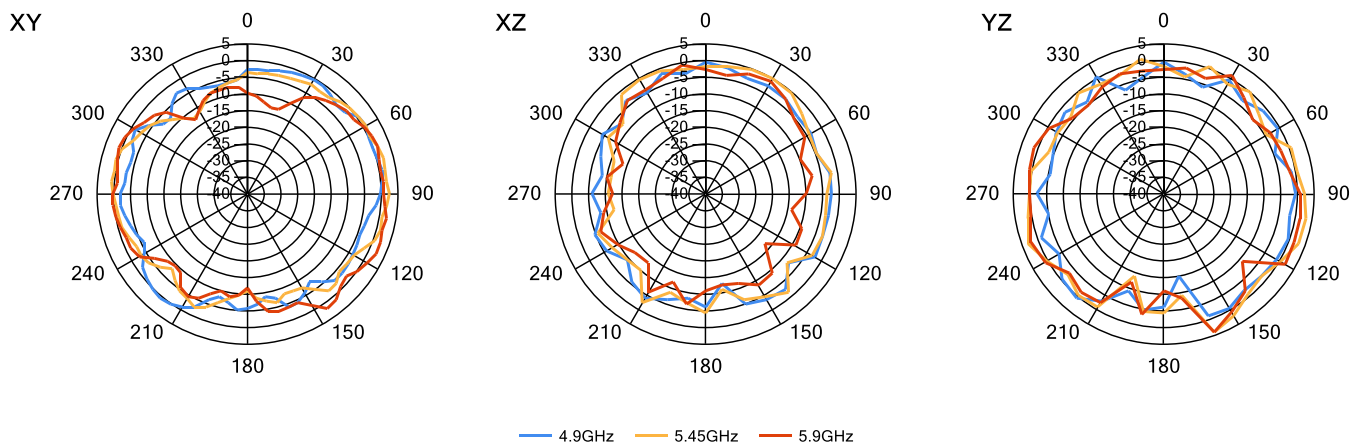

8. Antenna Dimensions

8.1 Dimensions FPC section

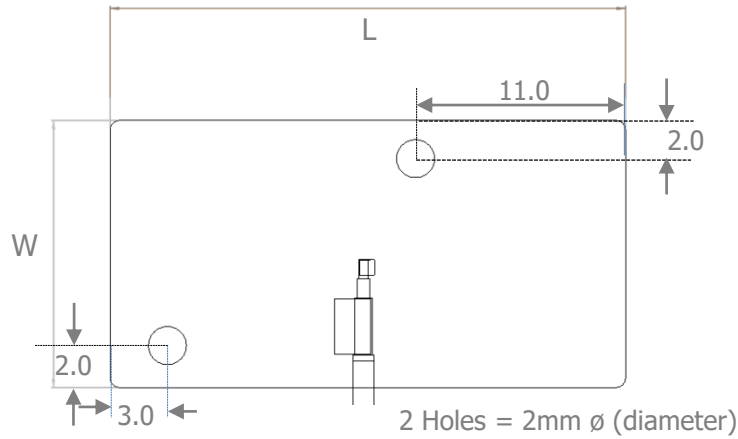

L	W	T
Length	Width	Thickness
27.0 ±0.2 (mm)	14.0 ±0.2 (mm)	0.15 (mm) nominal

All dimensions in mm

8.2 Dimensions assembled

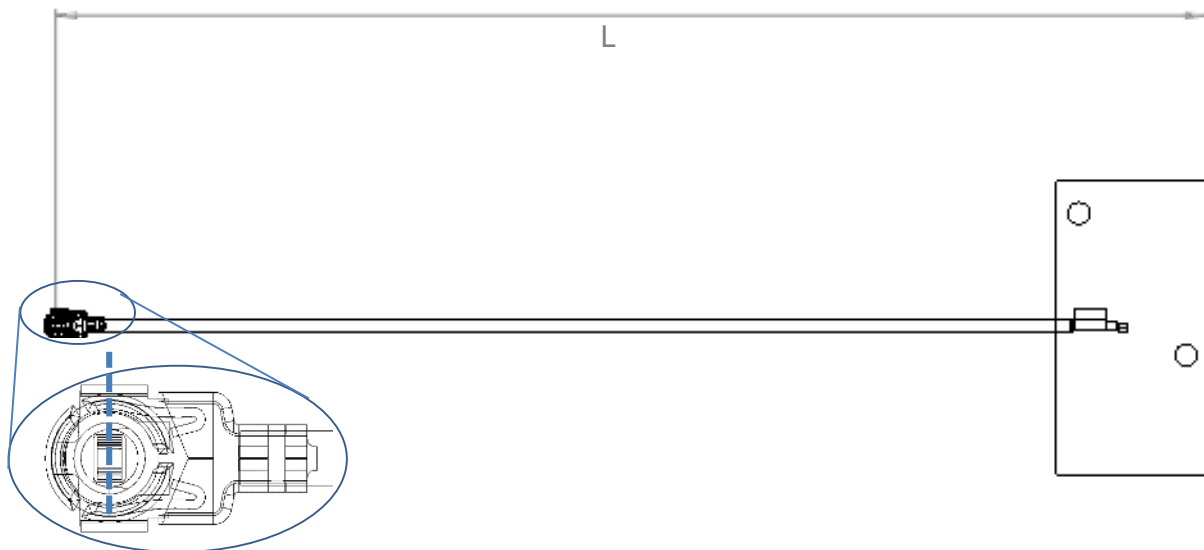

SRF2W021-50	SRF2W021-100	SRF2W021-150
L	L	L
57 ±2.0 (mm)	107 ±2.0 (mm)	157 ±2.0 (mm)

8.3 IPEX Connector

I-PEX	
Material	Copper Alloy
Plating	Ag

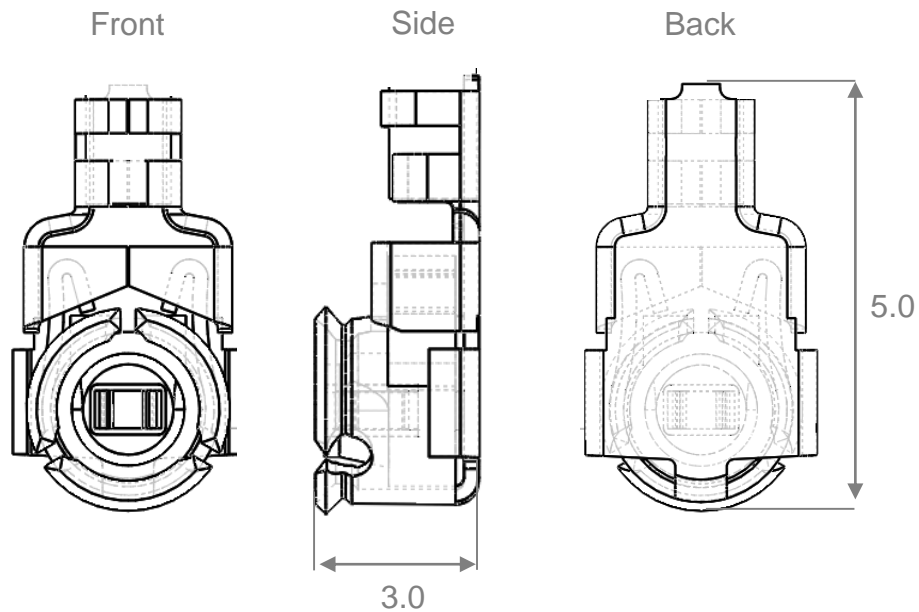

All dimensions in mm

8.4 Assembly

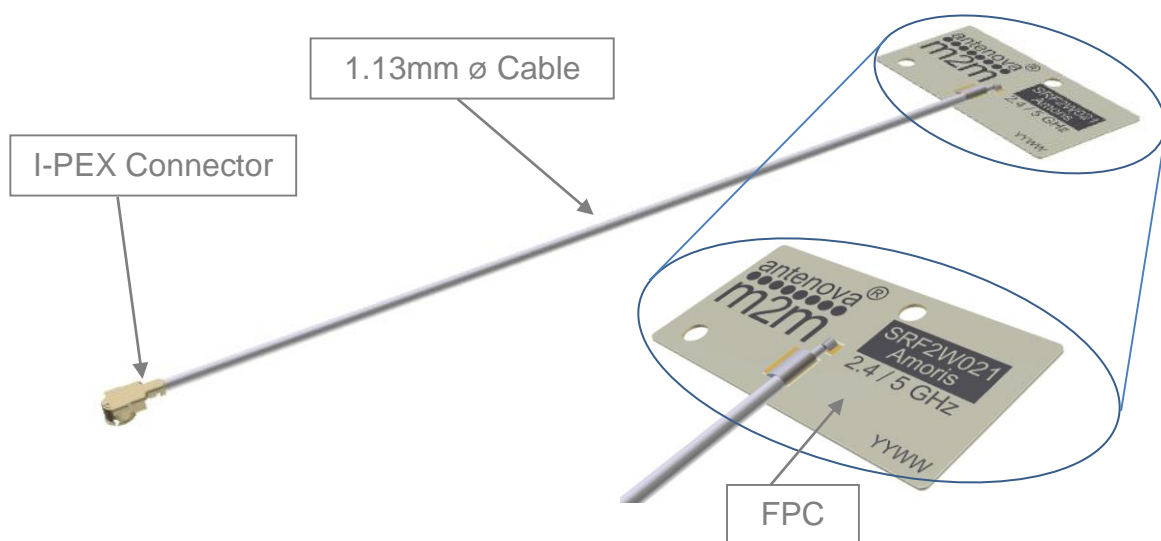

9. Electrical Interface

9.1 Host Interface

The host PCB requires the mating connector which is the IPEX MHF (UFL) receptacle. The location should be close to the chip/modules pin for the RF. Any feed from this receptacle should be maintained at 50Ω impedance.

9.2 Transmission Line

All transmission lines should be designed to have a characteristic impedance of 50Ω.

- The length of the transmission lines should be kept to a minimum
- Any other parts of the RF system like transceivers, power amplifiers, etc, should also be designed to have an impedance of 50 Ω

Once the material for the PCB has been chosen (PCB thickness and dielectric constant), a coplanar transmission line can easily be designed using any of the commercial software packages for transmission line design. For the chosen PCB thickness, copper thickness and substrate dielectric constant, the program will calculate the appropriate transmission line width and gaps on either side of the feed.

A DC blocking capacitor should be placed in line to protect the RF front end.

10. Mechanical Fixing

The antenna uses 3M 468MP adhesive on the reverse side of the FPC. The antenna has a easy access split line to peel off to reveal the adhesive side. It is designed for a one time fix to a clean smooth surface.

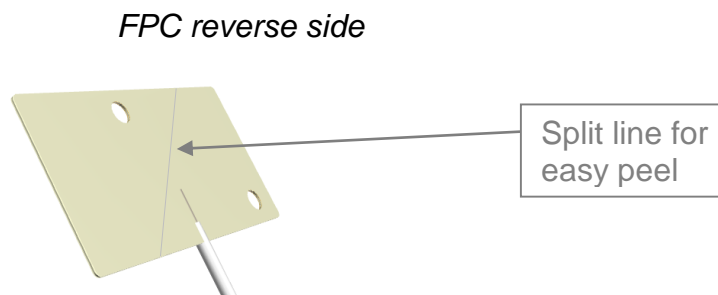

11.0 Antenna Integration Guide

11.1 Placement

For placing the FPC antenna within a device, the host PCB size is not a factor as with PCB mounted antennas. However, placement still needs to follow some basic rules, as any antenna is sensitive to its environment.

Six spatial directions are shown below. The antenna FPC section should ideally have minimum of three directions free from obstructions to be able to operate effectively. The other directions will have obstacles in their paths, these directions still require a minimum clearance. These minimum clearances are further defined in this section. The plastic case is not included in this, only metal objects/components that will obstruct or come in close proximity to the antenna.

Six spatial directions relative to FPC

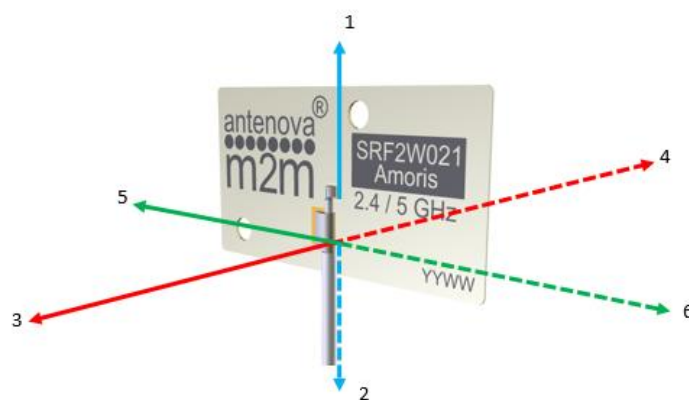

Example with 4 spatial directions clear

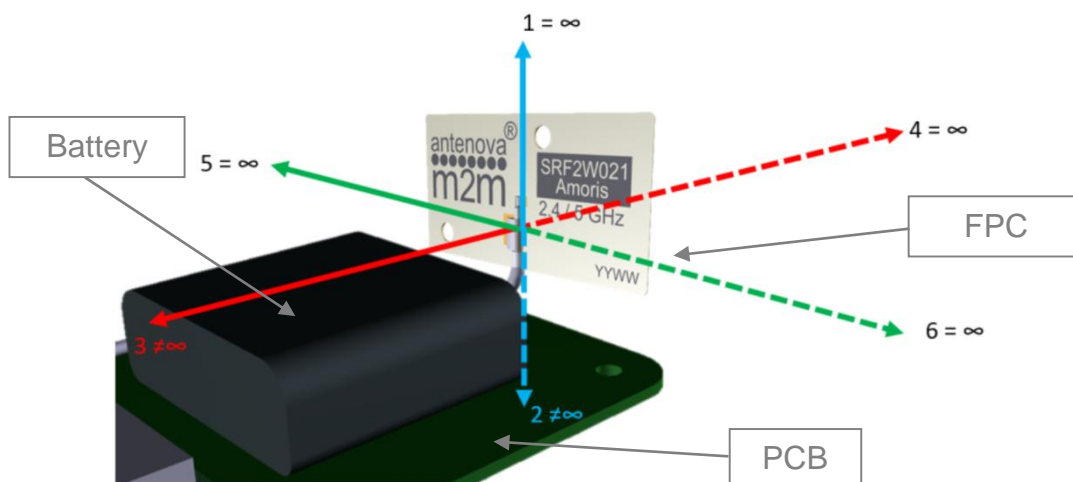

11.2 Orientation of FPC

The orientation of the FPC with respect to the host PCB should be defined depending on the unit. The proximity of the GND will have an influence on the antenna so the PCB location relative to the antenna should be considered.

The orientation the FPC will normally be placed in one of three of the following options for orientation. In each option a distance (d) is the critical dimension to consider. Below shows the minimum value of (d) for each. Other obstructions may increase this dimension.

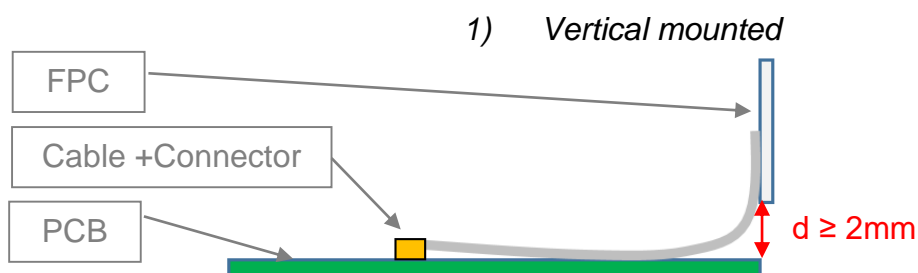

1) *Co-planar to PCB*

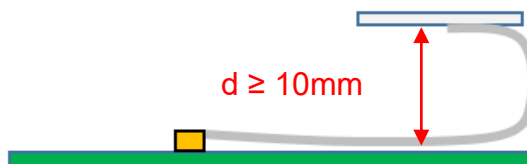

2) *Planar to PCB (Same plane)*



11.3 Device Integration example

An example of integration within a device is shown below. The device contains the major components along with the device outer case. The FPC is shown adhered to the inside of the device plastic housing. The cable routing is along the PCB so as not to interfere with any other component. The length of the cable is sufficient to allow ease of assembly when produced (SRF2W021-050)

The FPC was placed on the same plane relative to the PCB, Due to the thin design of the device, this was the optimal location.

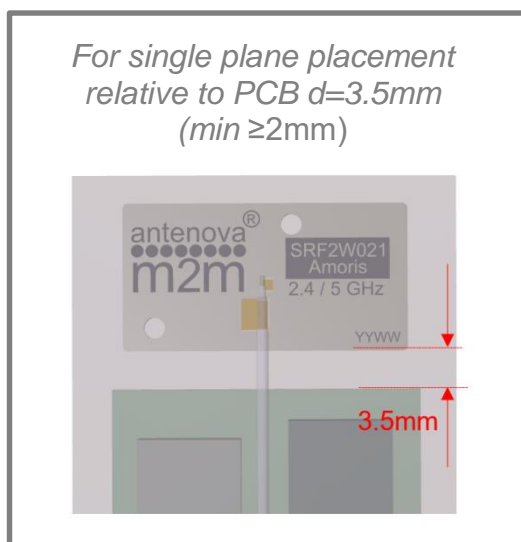
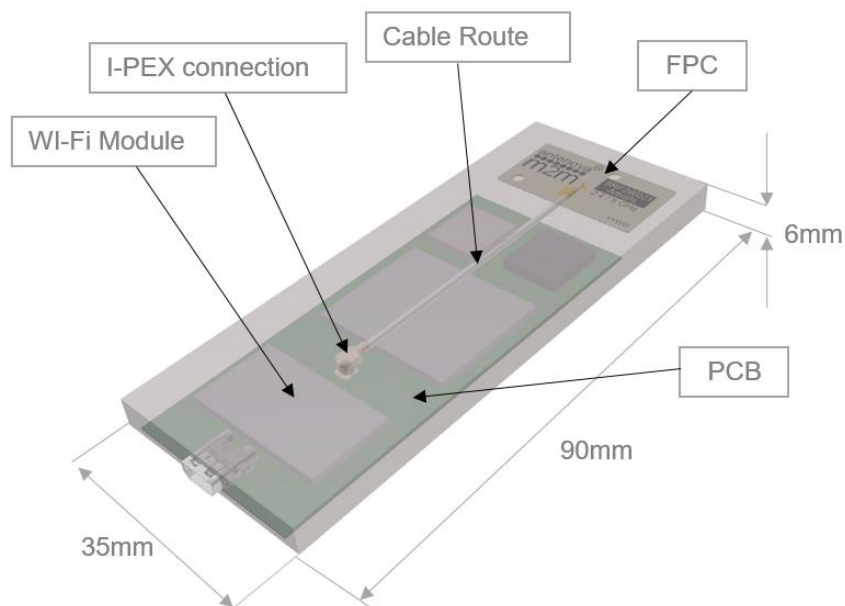

12. Hazardous Material Regulation Conformance

The antenna has been tested to conform to RoHS requirements. A certificate of conformance is available from Antenova M2M's website.

13. Packaging

The antennas are stored in individual plastic (PE) bags. Then stored within a second bag of 10pcs.

Single antenna per bag



10 units per second bag (Labelled)

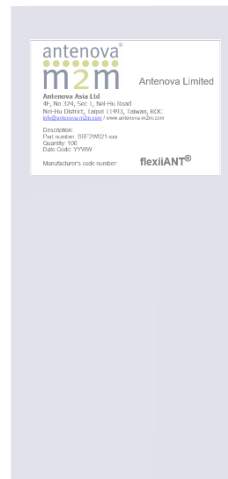

13.1 Optimal Storage Conditions

Temperature	-10°C to 40°C
Humidity	Less than 75% RH
Shelf life	24 Months
Storage place	Away from corrosive gas and direct sunlight
Packaging	Antennas should be stored in unopened sealed manufacturer's plastic packaging.

The shelf life of the antenna is two years, provided the bag of 10 pieces remains factory sealed.

13.2 Label Information

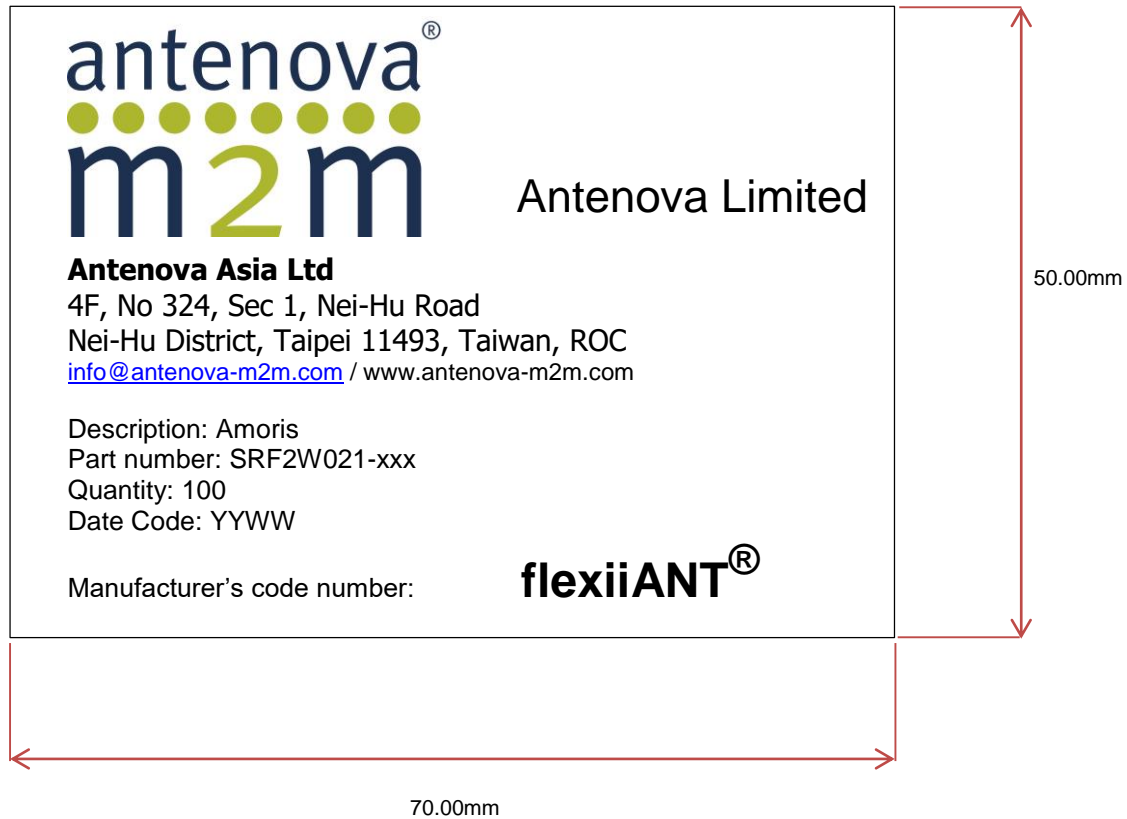



www.antenova-m2m.com

Corporate Headquarters

Antenova Limited
2nd Floor Titan Court
Bishop Square
Hatfield
AL10 9NA
UK

Tel: +44 1233 810600

Email: sales@antenova-m2m.com

North America Headquarters

Antenova Limited
100 Brush Creek Road, Suite 103
Santa Rosa
California 95404
USA

Tel: +1 707 890 5202

Email: sales@antenova-m2m.com

Asia Headquarters

Antenova Asia Limited
4F, No. 324, Sec. 1, Hei-Hu Road
Hei-Hu District
Taipei 11493
Taiwan, ROC

Tel: +886 (0) 2 8797 8630

Fax: +886 (0) 2 8797 6890

Email: sales@antenova-m2m.com

Copyright© Antenova Ltd. All Rights Reserved. Antenova ®, Antenova M2M ®, gigaNOVA ® , the Antenova product family names, and the Antenova and Antenova M2M logos are trademarks and/or registered trademarks of Antenova Ltd. Any other names and/or trademarks belong to their respective companies.

The materials provided herein are believed to be reliable and correct at the time of printing. Antenova does not warrant the accuracy or completeness of the information, text, graphics or other items contained within this information. Antenova further assumes no responsibility for the use of this information, and all such information shall be entirely at the user's risk.



Certificate No: 4598

Antennas for Wireless M2M Applications